

Dimension			
L	W	H	
325.8	107	41 (1U)	mm
12.82	4.21	1.61 (1U)	inch

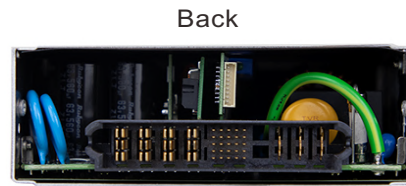
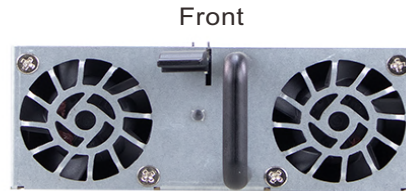

Features

- Universal AC input / Full range
- Power supply or charger mode selectable by PMBus, CANBus or SBP-001(only for 24V/48V models)
- Built-in 2/3 stage charging curves and programmable curve (only for 24V/48V models)
- High efficiency up to 94.5%
- Built-in programmable output voltage and output current
- Built-in OR-ing FET or Diode, support hot swap (hot plug)
- Active current sharing up to 10 rack shelves and the maximum power supply that can be connected in parallel is 40 units
- Support PMBus/CANBus protocol
- Built-in intelligent fan speed control
- Protections: Short circuit / Overload / Over voltage / Over temperature
- Design refer to SEMI F47 standard specification
- 5 years warranty

Applications

- Industrial automation
- Distributed power architecture system
- Wireless/telecommunication solution
- Redundant power system
- Large scale DC UPS or emergency backup system
- Electric scooter or vehicle charger station
- Wastewater treatment system
- Electrolysis system

GTIN CODE

MW Search: <https://www.meanwell.com/serviceGTIN.aspx>

Description

NCP-3200 is a 3.2KW dual-purpose(Switching Power Supply & Charger) rack-mounted AC/DC power supply with 1U low profile design and high power density up to 37W/inch³. This series operates at 90~264VAC input voltage and offers the models with the DC output mostly demanded by the industry. Each model is cooled by the built-in DC fan with fan speed control and working for the temperature up to 70°C. NCP-3200 provides vast design flexibility by equipping with PMBus and CANbus, two international communication protocols which can be selected for industrial control and power supply control, and can also be used directly with intelligent controller CMU2. Active current sharing up to 10 rack shelves (DHP-1UT-B) and the maximum power supply that can be connected in parallel is 40 units, remote ON/OFF control, auxiliary power, alarm signal, and others.

Model Encoding / Order Information

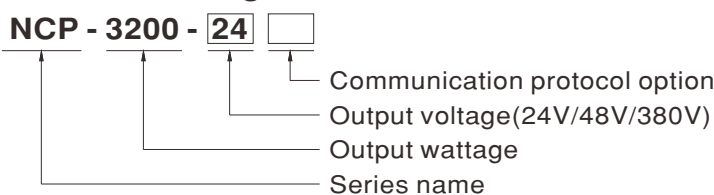

- ※ Note 1: 19" rack shelf, DHP-1UT-B(HV), available. Details available on <http://www.meanwell.com/>
- ※ Note 2: Control/Monitor unit, CMU2, available. Details available on <http://www.meanwell.com/>

Type	Communication Protocol	Note
Blank	PMBus protocol	In Stock
CAN	CANBus protocol	In Stock

SPECIFICATION FOR POWER SUPPLY MODE (Default)

MODEL	NCP-3200-24		NCP-3200-48		
OUTPUT	DC VOLTAGE (factory default)	24V		48V	
	RATED CURRENT (factory default)	133A		67A	
	CURRENT RANGE	0 ~ 133A		0 ~ 67A	
	RATED POWER (max.)	3192W		3216W	
	RIPPLE & NOISE (max.) Note.2,3	300mVp-p		480mVp-p	
	VOLTAGE ADJ. RANGE	23.5 ~ 30V		47.5 ~ 58.8V	
	VOLTAGE TOLERANCE Note.4	± 1.0%		± 1.0%	
	LINE REGULATION	± 0.5%		± 0.5%	
	LOAD REGULATION	± 0.5%		± 0.5%	
	SETUP, RISE TIME	1500ms, 60ms/230VAC at full load			
HOLD UP TIME (Typ.)	16ms / 230VAC at 70% load		8ms / 230VAC at full load		
INPUT	VOLTAGE RANGE Note.6	90 ~ 264VAC 127 ~ 400VDC			
	FREQUENCY RANGE	47 ~ 63Hz			
	POWER FACTOR (Typ.)	0.97/230VAC at full load			
	EFFICIENCY (Typ.) Note.7	93.5%		94.5%	
	AC CURRENT (Typ.) Note.6	17A/230VAC			
	INRUSH CURRENT (Typ.)	COLD START 55A/230VAC			
	LEAKAGE CURRENT	<2mA / 230VAC			
PROTECTION	OVERLOAD	105 ~ 115% rated current Protection type : Constant current limiting, shut down O/P voltage after 5 sec. After O/P voltage falls, re-power on to recover			
	OVER VOLTAGE	31.5 ~ 37.5V	63 ~ 75V Protection type : Shut down o/p voltage, re-power on to recover		
	OVER TEMPERATURE	Shut down o/p voltage, recovers automatically after temperature goes down			
	FUNCTION	Adjustment of output voltage is allowable to 50 ~ 125% of nominal output voltage Please refer to the Function Manual in following pages			
FUNCTION	PROGRAMMABLE(PV)	Adjustment of constant current level is allowable to 20 ~ 100% of rated current Please refer to the Function Manual in following pages			
	CONSTANT CURRENT LEVEL PROGRAMMABLE(PC)	Adjustment of constant current level is allowable to 20 ~ 100% of rated current Please refer to the Function Manual in following pages			
	REMOTE ON-OFF CONTROL	By electrical signal or dry contact Power ON:short Power OFF:open. Please refer to the Function Manual in following pages			
	REMOTE SENSE	Compensate voltage drop on the load wiring up to 0.5V. Please refer to the Function Manual in following pages			
	CURRENT SHARING	Active current sharing up to 10 rack shelves(DHP-1UT-B) and the maximum supply units that can be connected in parallel is 40			
	AUXILIARY POWER	5V @ 0.3A, tolerance ± 10%, ripple 150mVp-p, 12V @ 0.8A, tolerance ± 10%, ripple 450mVp-p			
	ALARM SIGNAL	Isolated TTL signal output for T-Alarm, AC-OK and DC-OK. Please refer to the Function Manual in following pages			
	ENVIRONMENT	WORKING TEMP.	-30 ~ +70°C (Refer to "Derating Curve")		
WORKING HUMIDITY		20 ~ 90% RH non-condensing			
STORAGE TEMP., HUMIDITY		-40 ~ +85°C, 10 ~ 95% RH non-condensing			
TEMP. COEFFICIENT		± 0.03%/°C (0 ~ 50°C)			
VIBRATION		10 ~ 500Hz, 2G 10min./1cycle, 60min. each along X, Y, Z axes			
SAFETY & EMC (Note 10)		SAFETY STANDARDS	UL62368-1, CSA C22.2 No. 62368-1, TUV BS EN/EN62368-1, EAC TP TC 004 approved ; Design refer to AS/NZS62368.1		
	WITHSTAND VOLTAGE	I/P-O/P:3KVAC I/P-FG:2KVAC O/P-FG:1.5KVAC			
	ISOLATION RESISTANCE	I/P-O/P, I/P-FG, O/P-FG:100M Ohms / 500VDC / 25°C / 70% RH			
	EMC EMISSION	Parameter	Standard		Test Level / Note
		Conducted	BS EN/EN55032 (CISPR32)		Class B
		Radiated	BS EN/EN55032 (CISPR32)		Class A
		Harmonic Current	BS EN/EN61000-3-2		Class A
		Voltage Flicker	BS EN/EN61000-3-3		-----
	EMC IMMUNITY	BS EN/EN55024, BS EN/EN61000-6-2; Design refer to SEMI F47 at 200VAC			
		Parameter	Standard		Test Level / Note
ESD		BS EN/EN61000-4-2		Level 3, 8KV air ; Level 2, 4KV contact	
Radiated		BS EN/EN61000-4-3		Level 3	
EFT / Burst		BS EN/EN61000-4-4		Level 3	
Surge		BS EN/EN61000-4-5		2KV/Line-Line 4KV/Line-Earth	
Conducted		BS EN/EN61000-4-6		Level 3	
Magnetic Field		BS EN/EN61000-4-8		Level 4	
Voltage Dips and Interruptions	BS EN/EN61000-4-11		>95% dip 0.5 periods, 30% dip 25 periods, >95% interruptions 250 periods		
OTHERS	MTBF	510.5K hrs min. Telcordia SR-332 (Bellcore) ; 45.8K hrs min. MIL-HDBK-217F (25°C)			
	DIMENSION	325.8*107*41mm (L*W*H)			
	PACKING	2.3Kg;4pcs/10.2Kg/1.09CUFT			
NOTE	<p>1. All parameters NOT specially mentioned are measured at 230VAC input, rated load and 25°C of ambient temperature.</p> <p>2. Ripple & noise are measured at 20MHz of bandwidth by using a 12" twisted pair-wire terminated with a 0.1uf & 47uf parallel capacitor.</p> <p>3. Under variable load application or parallel operation ripple of the output voltage may be higher than the SPEC at light load condition. It will go back to normal ripple level once the output load is more than 5%.</p> <p>4. Tolerance : includes set up tolerance, line regulation and load regulation.</p> <p>5. RCM is on a voluntary basis and meets relevant IEC or AS/NZS standards complying with AS/NES 4417.1.</p> <p>6. Derating may be needed under low input voltages. Please check the derating curve for more details.</p> <p>7. The efficiency is measured at 75% load.</p> <p>8. If use PV signal to adjust Vo, under certain operating conditions, ripple noise of Vo might slightly go over rating defined in this specification.</p> <p>9. Output will shut down after O/P voltage is below < 80% of Vset for 5 sec, re-power on to recover.</p> <p>10. The power supply is considered a component which will be installed into a final equipment. All the EMC tests are been executed by mounting the unit on a 600mm*900mm metal plate with 1mm of thickness. The final equipment must be re-confirmed that it still meets EMC directives. For guidance on how to perform these EMC tests, please refer to "EMI testing of component power supplies." (as available on https://www.meanwell.com/Upload/PDF/EMI_statement_en.pdf)</p> <p>11. The ambient temperature derating of 3.5°C/1000m with fanless models and of 5°C/1000m with fan models for operating altitude higher than 2000m(6500ft).</p> <p>※ Product Liability Disclaimer : For detailed information, please refer to https://www.meanwell.com/serviceDisclaimer.aspx</p>				

SPECIFICATION FOR POWER SUPPLY MODE (Default)

MODEL		NCP-3200-380		
OUTPUT	DC VOLTAGE (factory default)	380V		
	CURRENT (factory default)	8.4A		
	CURRENT RANGE	0 ~ 9.6A		
	RATED POWER (max.)	3206.4W		
	FULL POWER VOLTAGE RANGE	334 ~ 400V		
	RIPPLE & NOISE (max.) Note.2,3	4000mVp-p		
	VOLTAGE ADJ. RANGE	260 ~ 400V		
	VOLTAGE TOLERANCE Note.4	± 1.0%		
	LINE REGULATION	± 0.5%		
	LOAD REGULATION	± 0.5%		
SETUP, RISE TIME	1500ms, 60ms/230VAC at full load			
HOLD UP TIME (Typ.)	16ms / 230VAC at 70% load 8ms / 230VAC at full load			
INPUT	VOLTAGE RANGE Note.6	90 ~ 264VAC 127 ~ 400VDC		
	FREQUENCY RANGE	47 ~ 63Hz		
	POWER FACTOR (Typ.)	0.97/230VAC at full load		
	EFFICIENCY (Typ.) Note.7	94%		
	AC CURRENT (Typ.) Note.6	17A/230VAC		
	INRUSH CURRENT (Typ.)	COLD START 55A/230VAC		
LEAKAGE CURRENT	<2mA / 230VAC			
PROTECTION	OVERLOAD	105 ~ 115% rated current Protection type : Constant current limiting, shut down O/P voltage after 5 sec. After O/P voltage falls, re-power on to recover		
	OVER VOLTAGE	420 ~ 480V Protection type : Shut down o/p voltage, re-power on to recover		
	OVER TEMPERATURE	Shut down o/p voltage, recovers automatically after temperature goes down		
FUNCTION	OUTPUT VOLTAGE PROGRAMMABLE(PV)	Adjustment of output voltage is allowable to 50 ~ 120% of nominal output voltage Please refer to the Function Manual in following pages		
	CONSTANT CURRENT LEVEL PROGRAMMABLE(PC)	Adjustment of constant current level is allowable to 20 ~ 100% of rated current Please refer to the Function Manual in following pages		
	REMOTE ON-OFF CONTROL	By electrical signal or dry contact Power ON:short Power OFF:open. Please refer to the Function Manual in following pages		
	CURRENT SHARING	Active current sharing up to 10 rack shelves(DHP-1UT-BHV) and the maximum supply units that can be connected in parallel is 40		
	AUXILIARY POWER	5V @ 0.3A, tolerance ± 10%, ripple 150mVp-p, 12V @ 0.8A, tolerance ± 10%, ripple 450mVp-p		
	ALARM SIGNAL	Isolated TTL signal output for T-Alarm, AC-OK and DC-OK. Please refer to the Function Manual in following pages		
ENVIRONMENT	WORKING TEMP.	-30 ~ +70°C (Refer to "Derating Curve")		
	WORKING HUMIDITY	20 ~ 90% RH non-condensing		
	STORAGE TEMP., HUMIDITY	-40 ~ +85°C, 10 ~ 95% RH non-condensing		
	TEMP. COEFFICIENT	± 0.03%/°C (0 ~ 50°C)		
	VIBRATION	10 ~ 500Hz, 2G 10min./1cycle, 60min. each along X, Y, Z axes		
SAFETY & EMC (Note 10)	SAFETY STANDARDS	UL62368-1, CSA C22.2 No. 62368-1, TUV BS EN/EN62368-1, EAC TP TC 004 approved ; Design refer to AS/NZS62368.1		
	WITHSTAND VOLTAGE	I/P-O/P:3KVAC I/P-FG:2KVAC O/P-FG:1.5KVAC		
	ISOLATION RESISTANCE	I/P-O/P, I/P-FG, O/P-FG:100M Ohms / 500VDC / 25°C / 70% RH		
	EMC EMISSION	Parameter	Standard	Test Level / Note
		Conducted	BS EN/EN55032 (CISPR32)	Class B
		Radiated	BS EN/EN55032 (CISPR32)	Class A
		Harmonic Current	BS EN/EN61000-3-2	Class A
	Voltage Flicker	BS EN/EN61000-3-3	-----	
	EMC IMMUNITY	BS EN/EN55024, BS EN/EN61000-6-2; Design refer to SEMI F47 at 200VAC		
		Parameter	Standard	Test Level / Note
ESD		BS EN/EN61000-4-2	Level 3, 8KV air ; Level 2, 4KV contact	
Radiated		BS EN/EN61000-4-3	Level 3	
EFT / Burst		BS EN/EN61000-4-4	Level 3	
Surge		BS EN/EN61000-4-5	2KV/Line-Line 4KV/Line-Earth	
Conducted		BS EN/EN61000-4-6	Level 3	
Magnetic Field		BS EN/EN61000-4-8	Level 4	
Voltage Dips and Interruptions	BS EN/EN61000-4-11	>95% dip 0.5 periods, 30% dip 25 periods, >95% interruptions 250 periods		
OTHERS	MTBF	510.5K hrs min. Telcordia SR-332 (Bellcore) ; 45.8K hrs min. MIL-HDBK-217F (25°C)		
	DIMENSION	325.8*107*41mm (L*W*H)		
	PACKING	2.3Kg;4pcs/10.2Kg/1.09CUFT		
NOTE	<p>1. All parameters NOT specially mentioned are measured at 230VAC input, rated load and 25°C of ambient temperature.</p> <p>2. Ripple & noise are measured at 20MHz of bandwidth by using a 12" twisted pair-wire terminated with a 0.1uf & 47uf parallel capacitor.</p> <p>3. Under variable load application or parallel operation ripple of the output voltage may be higher than the SPEC at light load condition. It will go back to normal ripple level once the output load is more than 5%.</p> <p>4. Tolerance : includes set up tolerance, line regulation and load regulation.</p> <p>5. RCM is on a voluntary basis and meets relevant IEC or AS/NZS standards complying with AS/NES 4417.1.</p> <p>6. Derating may be needed under low input voltages. Please check the derating curve for more details.</p> <p>7. The efficiency is measured at 75% load.</p> <p>8. If use PV signal to adjust Vo, under certain operating conditions, ripple noise of Vo might slightly go over rating defined in this specification.</p> <p>9. Output will shut down after O/P voltage is below < 80% of Vset for 5 sec, re-power on to recover.</p> <p>10. The power supply is considered a component which will be installed into a final equipment. All the EMC tests are been executed by mounting the unit on a 600mm*900mm metal plate with 1mm of thickness. The final equipment must be re-confirmed that it still meets EMC directives. For guidance on how to perform these EMC tests, please refer to "EMI testing of component power supplies." (as available on https://www.meanwell.com/Upload/PDF/EMI_statement_en.pdf)</p> <p>11. The ambient temperature derating of 3.5°C/1000m with fanless models and of 5°C/1000m with fan models for operating altitude higher than 2000m(6500ft).</p> <p>※ Product Liability Disclaimer : For detailed information, please refer to https://www.meanwell.com/serviceDisclaimer.aspx</p>			



SPECIFICATION FOR CHARGER MODE (Selectable by PMBus, CANBus or SBP-001)

MODEL		NCP-3200-24	NCP-3200-48	
OUTPUT	BOOST CHARGE VOLTAGE(Vboost)(default)	28.8V	57.6V	
	FLOAT CHARGE VOLTAGE(Vfloat)(default)	27.6V	55.2V	
	CONSTANT CURRENT(CC)(default)	110A	55A	
	RECOMMENDED BATTERY CAPACITY(AMP HOURS) Note.3	330 ~ 1000Ah	180 ~ 550Ah	
	LEAKAGE CURRENT FROM BATTERY(Typ.)	<1.5mA		
INPUT	VOLTAGE RANGE Note.4	90 ~ 264VAC 127 ~ 400VDC		
	FREQUENCY RANGE	47 ~ 63Hz		
	POWER FACTOR (Typ.)	0.97/230VAC at full load		
	EFFICIENCY (Typ.)	93%	94%	
	AC CURRENT (Typ.) Note.4	17A/230VAC		
	INRUSH CURRENT (Typ.)	COLD START 55A/230VAC		
PROTECTION	LEAKAGE CURRENT	<2mA / 230VAC		
	OVER VOLTAGE	31.5 ~ 37.5V	63 ~ 75V	
	OVER TEMPERATURE	Protection type : Shut down o/p voltage, re-power on to recover Shut down o/p voltage, recovers automatically after temperature goes down		
FUNCTION	REMOTE ON-OFF CONTROL	By electrical signal or dry contact Power ON:short Power OFF:open. Please refer to the Function Manual in following pages		
	CURRENT SHARING	Active current sharing up to 10 rack shelves(DHP-1UT-B) and the maximum supply units that can be connected in parallel is 40		
	AUXILIARY POWER	5V @ 0.3A, tolerance $\pm 10\%$, ripple 150mVp-p, 12V @ 0.8A, tolerance $\pm 10\%$, ripple 450mVp-p		
	ALARM SIGNAL	Isolated TTL signal output for T-Alarm, AC-OK and DC-OK. Please refer to the Function Manual in following pages		
ENVIRONMENT	WORKING TEMP.	-30 ~ +70°C (Refer to "Derating Curve")		
	WORKING HUMIDITY	20 ~ 90% RH non-condensing		
	STORAGE TEMP., HUMIDITY	-40 ~ +85°C, 10 ~ 95% RH non-condensing		
	TEMP. COEFFICIENT	$\pm 0.03\%/^{\circ}\text{C}$ (0 ~ 50°C)		
	VIBRATION	10 ~ 500Hz, 2G 10min./1cycle, 60min. each along X, Y, Z axes		
SAFETY & EMC (Note 6)	SAFETY STANDARDS	UL62368-1, CSA C22.2 No. 62368-1, TUV BS EN/EN62368-1, EAC TP TC 004 approved ; Design refer to AS/NZS62368.1		
	WITHSTAND VOLTAGE	I/P-O/P:3KVAC I/P-FG:2KVAC O/P-FG:1.5KVAC		
	ISOLATION RESISTANCE	I/P-O/P, I/P-FG, O/P-FG:100M Ohms / 500VDC / 25°C / 70% RH		
	EMC EMISSION	Parameter	Standard	Test Level / Note
		Conducted	BS EN/EN55032 (CISPR32)	Class B
		Radiated	BS EN/EN55032 (CISPR32)	Class A
		Harmonic Current	BS EN/EN61000-3-2	Class A
		Voltage Flicker	BS EN/EN61000-3-3	----
	EMC IMMUNITY	BS EN/EN55024, BS EN/EN61000-6-2		
		Parameter	Standard	Test Level / Note
		ESD	BS EN/EN61000-4-2	Level 3, 8KV air ; Level 2, 4KV contact
		Radiated	BS EN/EN61000-4-3	Level 3
		EFT / Burst	BS EN/EN61000-4-4	Level 3
		Surge	BS EN/EN61000-4-5	2KV/Line-Line 4KV/Line-Earth
		Conducted	BS EN/EN61000-4-6	Level 3
Magnetic Field		BS EN/EN61000-4-8	Level 4	
Voltage Dips and Interruptions	BS EN/EN61000-4-11	>95% dip 0.5 periods, 30% dip 25 periods, >95% interruptions 250 periods		
OTHERS	MTBF	510.5K hrs min. Telcordia SR-332 (Bellcore) ; 45.8K hrs min. MIL-HDBK-217F (25°C)		
	DIMENSION	325.8*107*41mm (L*W*H)		
	PACKING	2.3Kg;4pcs/10.2Kg/1.09CUFT		
NOTE	<p>1. Modification for charger specification may be required for different battery specification. Please contact battery vendor and MEAN WELL for details.</p> <p>2. All parameters NOT specially mentioned are measured at 230VAC input, rated load and 25°C of ambient temperature.</p> <p>3. This is MEAN WELL's suggested range. Please consult your battery manufacturer for their suggestions about maximum charging current limitation.</p> <p>4. Derating may be needed under low input voltages. Please check the derating curve for more details.</p> <p>5. RCM is on a voluntary basis and meets relevant IEC or AS/NZS standards complying with AS/NES 4417.1.</p> <p>6. The charger is considered a component which will be installed into a final equipment. All the EMC tests are been executed by mounting the unit on a 600mm*900mm metal plate with 1mm of thickness. The final equipment must be re-confirmed that it still meets EMC directives. For guidance on how to perform these EMC tests, please refer to "EMI testing of component power supplies." (as available on https://www.meanwell.com/Upload/PDF/EMI_statement_en.pdf)</p> <p>7. The ambient temperature derating of 3.5°C/1000m with fanless models and of 5°C/1000m with fan models for operating altitude higher than 2000m(6500ft).</p> <p>※ Product Liability Disclaimer : For detailed information, please refer to https://www.meanwell.com/serviceDisclaimer.aspx</p>			

■ BLOCK DIAGRAM

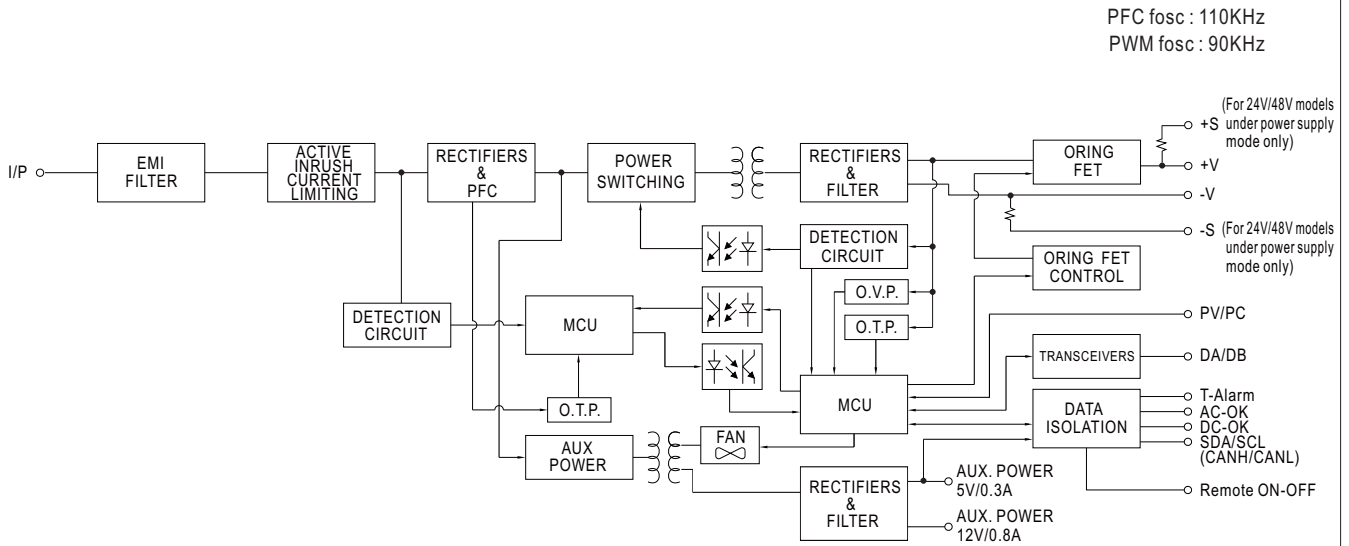

■ STATIC CHARACTERISTICS

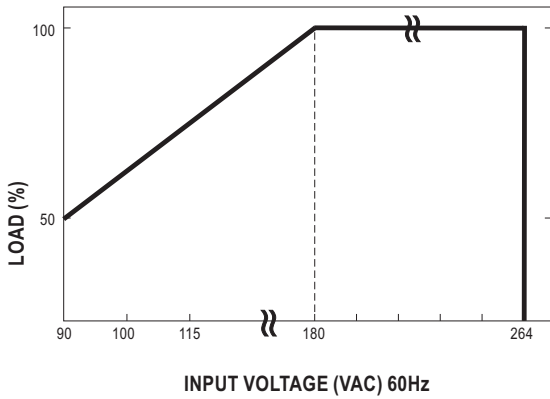

■ DERATING LOADs vs INPUT VOLTAGE

INPUT \ MODEL	24V	48V	380V
180~264VAC	3192W 133A	3216W 67A	3192W 8.4A
90VAC	1596W 66.5A	1608W 33.5A	1596W 4.2A

■ DERATING CURVE

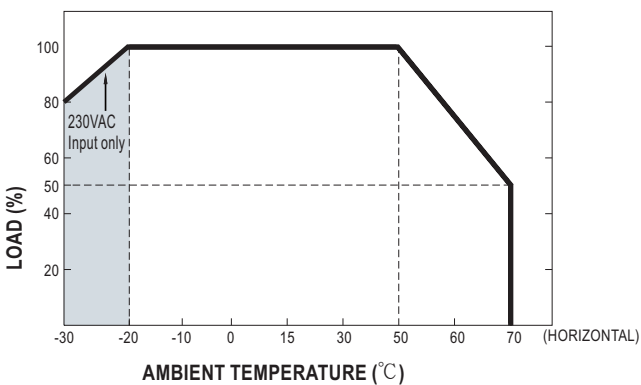

■ EFFICIENCY vs LOAD (48V MODEL)

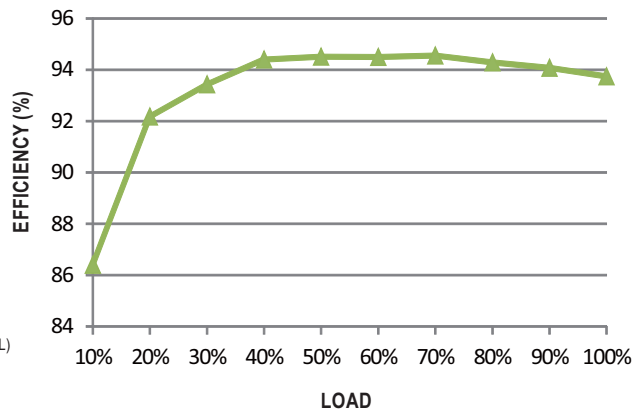

⊙ The curve above is measured at 230VAC.

FUNCTION MANUAL

1. Charging Curve (Charger mode only available for 24V/48V models)

- ※ By default, the unit operates in power supply mode, and it can be configured to charger mode by PMBus, CANBus or SBP-001.
- ※ By factory default, this charger performs the default curve which can be programmed via PMBus and CANBus.
- ※ To accommodate the parameters of the charging curve, SBP-001, the smart battery charging programmer designed by MEAN WELL, and a personal computer are needed. Please contact MEAN WELL for details.

※ 2 stage charging curve

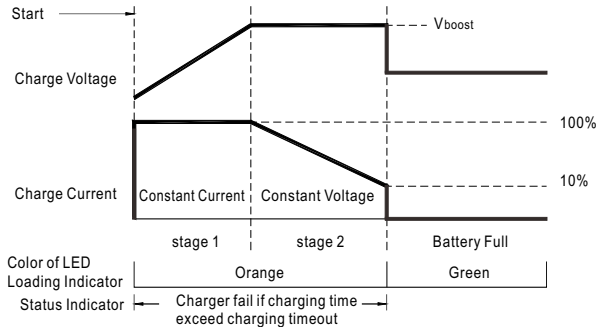

State	NCP-3200-24	NCP-3200-48
Constant Current	110A	55A
Vboost	28.8V	57.6V

◎ Suitable for lead-acid batteries (flooded, Gel and AGM) and Li-ion batteries (lithium iron and lithium manganese).

※ 3 stage charging curve (default)

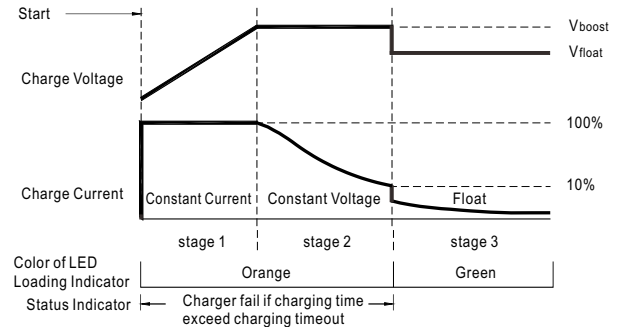

State	NCP-3200-24	NCP-3200-48
Constant Current	110A	55A
Vboost	28.8V	57.6V
Vfloat	27.6V	55.2V

◎ Suitable for lead-acid batteries (flooded, Gel and AGM) and Li-ion batteries (lithium iron and lithium manganese).

◎ Embedded 2 stage charging curves

MODEL	Description	CC(default)	Vboost
24V	Default, programmable	110A	28.8
	Pre-defined, gel battery		28
	Pre-defined, flooded battery		28.4
	Pre-defined, AGM battery		29
48V	Default, programmable	55A	57.6
	Pre-defined, gel battery		56
	Pre-defined, flooded battery		56.8
	Pre-defined, AGM battery		58

◎ Embedded 3 stage charging curves

MODEL	Description	CC(default)	Vboost	Vfloat
24V	Default, programmable	110A	28.8	27.6
	Pre-defined, gel battery		28	27.2
	Pre-defined, flooded battery		28.4	26.8
	Pre-defined, AGM battery		29	27
48V	Default, programmable	55A	57.6	55.2
	Pre-defined, gel battery		56	54.4
	Pre-defined, flooded battery		56.8	53.6
	Pre-defined, AGM battery		58	54

2. Front Panel LED Indicators

※ LED Status Indicators (for power supply mode)

LED	Description
● Green	The power supply functions normally.
● Red	The LED will present a constant red light when the abnormal status (OTP, OLP, fan fail) arises.
☀ Red (Flashing)	The LED will flash with the red light when the internal temperature reaches 60°C; under this condition, the unit still operates normally without entering OTP. (In the meantime, an alarm signal will be sent out through the PMBus/CANBus interface.)

※ LED Status Indicators (for charger mode)

LED	Description
● Green	Float (stage 3)
● Orange	Charging (stage 1 or stage 2)
● Red	The LED will present a constant red light when the abnormal status (OTP, OLP, fan fail and charging timeout) arises.
☀ Red (Flashing)	The LED will flash with the red light when the internal temperature reaches 60°C; under this condition, the unit still operates normally without entering OTP. (In the meantime, an alarm signal will be sent out through the PMBus/CANBus interface.)

3. Voltage Drop Compensation

3.1 Remote Sense (For 24V/48V models under power supply mode only)

※ The Remote Sense compensates voltage drop on the load wiring up to 0.5V

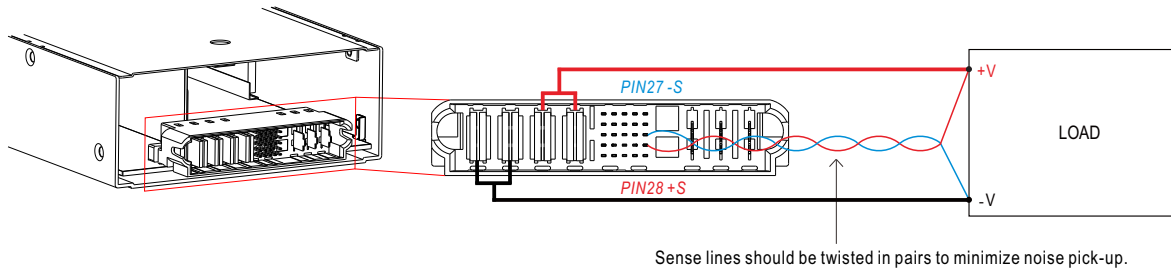

◎ The +S signal should be connected to the positive terminal of the load whereas -S signal to the negative terminal.

3.2 Local Sense (For 24V/48V models under power supply mode only)

※ The +S,-S have to be connected to the +V(signal),-V(signal), respectively, as the following diagram, in order to get the correct output voltage if Remote Sense is not used.

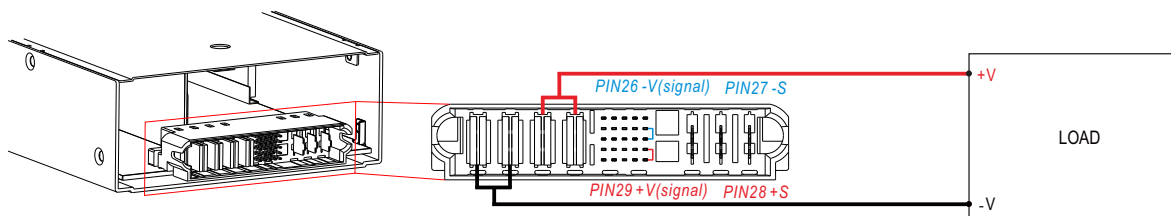

4. Output Voltage Programming (or, PV / remote voltage programming / remote adjust / margin programming / dynamic voltage trim)

※ In addition to the adjustment via the built-in potentiometer, the output voltage can be trimmed to 50~125%(24/48V models) or 50~120%(380V model) of the nominal voltage by applying EXTERNAL VOLTAGE.

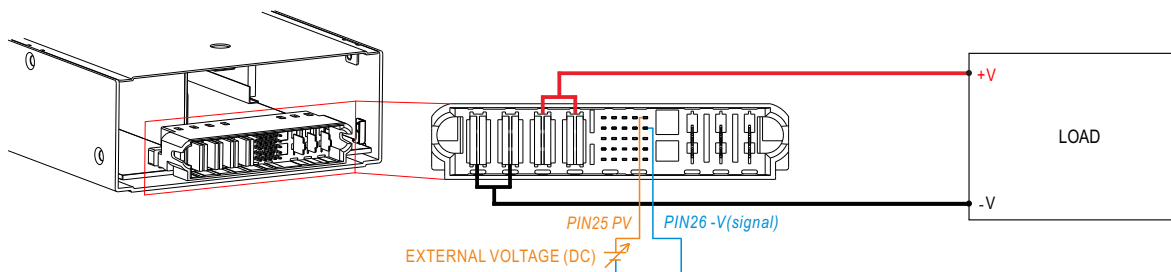

◎ For Remote Sense / Local Sense, please refer to "Voltage Drop Compensation" section.

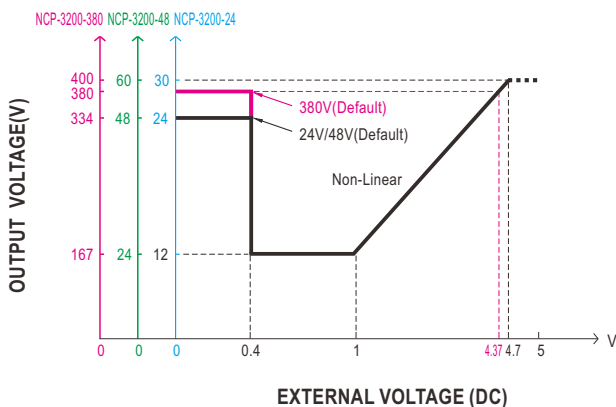

◎ For power supply mode
 ◎ The 100% output voltage is 24/48/334V.

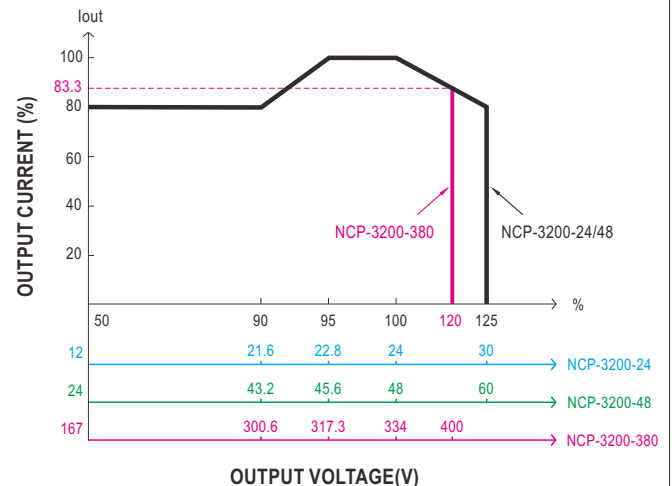

◎ The rated current should change with the Output Voltage Programming accordingly.
 ◎ The 100% output current is 133/67/9.6A.
 ◎ For Remote Sense / Local Sense, please refer to "Voltage Drop Compensation" section.

5. Constant Current Level Programming (or, PC / remote current programming / dynamic current trim)

- ※ The constant current level can be trimmed to 20~100% of the rated current by applying EXTERNAL VOLTAGE.
- ※ If setting output current to a much lower level, as output status turns to constant current mode, it might cause higher current ripple under such condition.

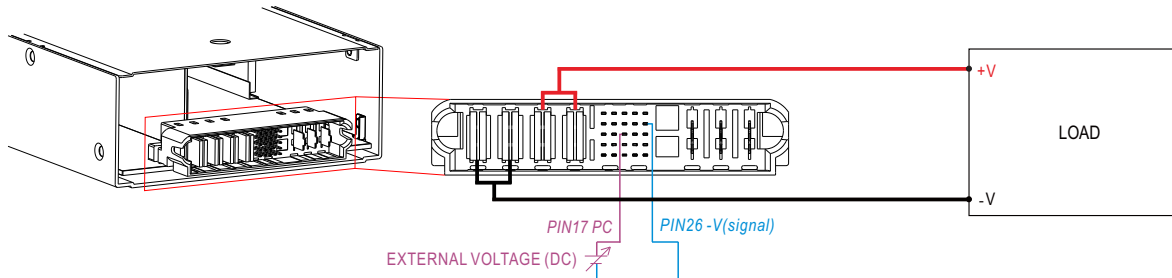

- ◎ For Remote Sense / Local Sense, please refer to "Voltage Drop Compensation" section.
- ◎ Output will shut down after O/P voltage is below < 80% of Vset for 5 sec, re-power on to recover.

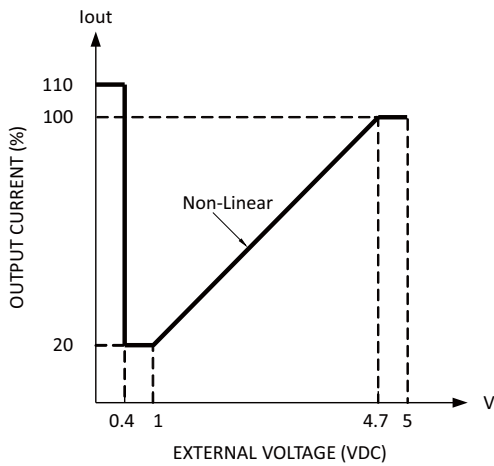

- ◎ The 100% output current is 133/67/9.6A.
- ◎ Notice the output power do not over rated power (max.)

6. Remote ON-OFF Control

The power supply can be turned ON/OFF individually or along with other units by using the "Remote ON-OFF" function.

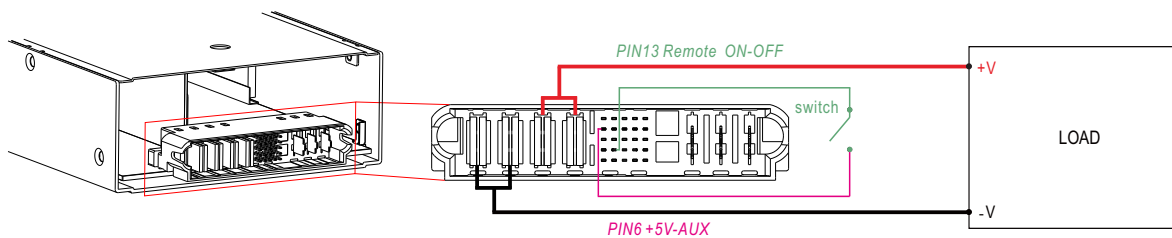

Between Remote ON-OFF and +5V-AUX	Power Supply Status
Switch Short	ON
Switch Open	OFF

7. PMBus Communication Interface

NCP-3200 supports PMBus Rev. 1.1 with maximum 100KHz bus speed, allowing information reading, status monitoring, output trimming, etc. For details, please refer to the Function Manual.

8. CANBus Communication Interface

NCP-3200 supports CAN 2.0B with maximum 250KHz bus speed, allowing information reading, status monitoring, output trimming, etc. For details, please refer to the User's Manual.

9. Alarm Signal Output

※ There are 3 alarm signals, DC-OK, AC-OK and T-ALARM, in TTL signal form, on CN1. These signals are isolated from output. The maximum sink current is 10mA.

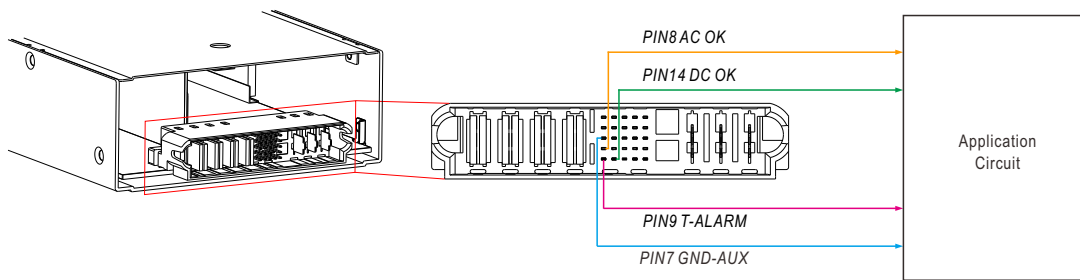

DC-OK signal	Power Supply Mode Status	Charger Mode Status
"High" > 3.5~5.5V	Vout ≤ 77%±5%	Vout ≤ 66%±5%
"Low" < -0.5~0.5V	Vout ≥ 80%±5%	Vout ≥ 67%±5%

AC-OK signal	Power Supply and Charger Mode Status
"High" > 3.5~5.5V	Input voltage ≥ 87Vrms
"Low" < -0.5~0.5V	Input voltage ≤ 75Vrms

T-ALARM signal	Power Supply and Charger Mode Status
"High" > 3.5~5.5V	OFF(OTP or Fan Fail)
"Low" < -0.5~0.5V	ON(Normal Work)

10. Parallel Operation

- ※ For parallel operation, please refer to the function manual of DHP-1UT-B(HV) rack system.
- ※ Read installation manual before using this device. For NCP-3200-380 high output voltage model, correct rack system DHP-1UT-BHV should be used. Fail to do so will cause permanent damage.

19" Rack shelf	DHP-1UT-B	DHP-1UT-B	DHP-1UT-BHV
Power supply or battery charger unit	NCP-3200-24*4	NCP-3200-48*4	NCP-3200-380*4

MECHANICAL SPECIFICATION

(Unit: mm , tolerance ±0.5mm)

Case No. 294B

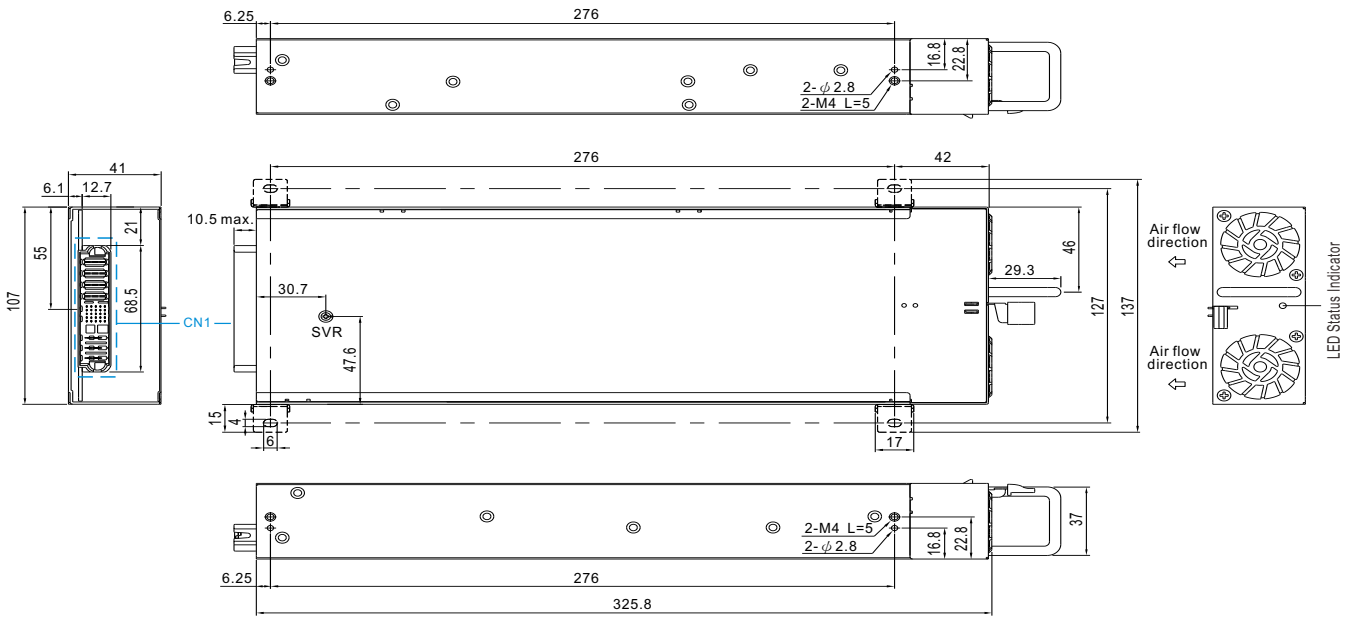

※ Input / Output Connector Pin No. Assignment(CN1) : C27309-10749-Y

(Any question about Mating connector, please contact MEANWELL'S sales representative.)

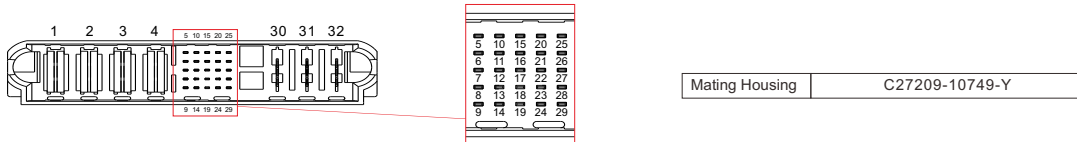

Pin No.	Function	Description
1,2	-V	Negative output terminal.
3,4	+V	Positive output terminal.
5	+12V-AUX	Auxiliary voltage output, 10.8~13.2V, referenced to GND-AUX (pin 7). The maximum load current is 0.8A. This output has the built-in "Oring diodes" and is not controlled by the Remote ON/OFF control.
6	+5V-AUX	Auxiliary voltage output, 4.5~5.5V, reference to GND_AUX(pin7). The maximum load current is 0.3A. The output has the built-in "Oring diodes" and is not controlled by the Remote ON/OFF control.
7	GND-AUX	Auxiliary voltage output GND. The signal return is isolated from the output terminals (+V & -V).
8	AC-OK	High (3.5 ~ 5.5V) : When the input voltage is $\geq 87V_{rms}$. Low (-0.5 ~ 0.5V) : When the input voltage is $\leq 75V_{rms}$. The maximum sourcing current is 10mA and only for output. (Note.2)
9	T-ALARM	High (3.5 ~ 5.5V) : When the internal temperature exceeds the limit of temperature alarm, or when fan fails. Low (-0.5 ~ 0.5V) : When the internal temperature is normal, and when fan normally works. The maximum sourcing current is 10mA and only for output.(Note.2)
10,24	NC	Standard model: Retain for future use
11	SCL	For PMBus model: Serial Clock used in the PMBus interface. (Note.2)
	CANL	For CANBus model: Data line used in CANBus interface. (Note.2)
12	SDA	For PMBus model: Serial Data used in the PMBus interface. (Note.2)
	CANH	For CANBus model: Data line used in CANBus interface. (Note.2)
13	Remote ON-OFF	The unit can turn the output ON/OFF by electrical signal or dry contact between Remote ON/OFF and +5V-AUX. (Note.2) Short (4.5 ~ 5.5V) : Power ON ; Open (-0.5 ~ 0.5V) : Power OFF ; The maximum input voltage is 5.5V.
14	DC-OK	For power supply mode High (3.5 ~ 5.5V) : When the Vout $\leq 77\% \pm 5\%$. Low (-0.5 ~ 0.5V) : When the Vout $\geq 80\% \pm 5\%$. The maximum sourcing current is 10mA and only for output. (Note.2)
		For charger mode High (3.5 ~ 5.5V) : When the Vout $\leq 66\% \pm 5\%$. Low (-0.5 ~ 0.5V) : When the Vout $\geq 67\% \pm 5\%$. The maximum sourcing current is 10mA and only for output. (Note.2) DC OK is associated with battery low protection.
15,16	DA,DB	Differential digital signal for parallel control. (Note.1)
17	PC	Connection for constant current level programing. (Note.1)
18,19,20,21	A2,A3,A4,A5	PMBus / CANBus interface address lines(for Rack system). (Note.1)
22,23	A0,A1	PMBus / CANBus interface address lines for Rack mountable front end rectifier. (Note.1)
25	PV	Connection for output voltage programming. (Note.1)
26	-V (Signal)	Negative output voltage signal. It is for local sense; and certain function reference; it cannot be connected directly to the load.
27	-S	Negative sensing for remote sense. (For 24V/48V models under power supply mode only)
	NC	Not available for NCP-3200-380
28	+S	Positive sensing for remote sense. (For 24V/48V models under power supply mode only)
	NC	Not available for NCP-3200-380
29	+V (Signal)	Positive output voltage signal. (For 24V/48V models under power supply mode only) It is for local sense; it cannot be connected directly to the load.
	NC	Not available for NCP-3200-380
30	FG	AC Ground connection.
32	AC/L	AC Line connection.
31	AC/N	AC Neutral connection.

Note1: Non-isolated signal, referenced to [-V(signal)].
Note2: Isolated signal, referenced to GND-AUX.